

MARITIME SAFETY INVESTIGATION REPORT
Rigid Inflatable boat (RIB)
ZODIAC 04
from
Mv WORLD EXPLORER
IMO 9871531



VERY SERIOUS MARITIME CASUALTY
Capsizing of a Zodiac craft
with loss of two lives

RELATÓRIO DE INVESTIGAÇÃO DE SEGURANÇA MARÍTIMA

Maritime safety investigation report

ZODIAC 04

from

MV WORLD EXPLORER

GAMA's registry 2022-492

Draft report circulated – 26/04/2023

Final report homologated – 02/05/2023

Relatório elaborado pelo Gabinete de Investigação de Acidentes Marítimos e da Autoridade para a Meteorologia Aeronáutica (GAMA), serviço da Administração Central do Estado que tem por missão investigar os acidentes e incidentes marítimos, com a maior eficácia e rapidez possível, visando identificar as respetivas causas, fatores contributivos, elaborar e divulgar os correspondentes relatórios e emitir recomendações em matéria de segurança marítima que visem reduzir a sinistralidade marítima.

O presente relatório foi elaborado respeitando as normas da Organização Marítima Internacional (OMI) e seguindo a Metodologia Comum estabelecida pela União Europeia.

Conforme disposto na Lei n.º 18/2012 de 07 de maio, que transpõe a Diretiva 2009/18/CE do Parlamento Europeu e do Conselho, as investigações do GAMA são independentes de organismos de regulação, operadores ou outros.

Não é o objetivo de uma investigação determinar culpa ou responsabilidade.

Este relatório não deverá ser usado para ações judiciais e nem ser usado em tribunal como evidência.

As recomendações de segurança que resultam deste relatório não podem, em caso algum, criar uma presunção de responsabilidade ou de culpa. Todas as horas são locais (UTC - 3) e todas as posições têm como datum geodésico de referência WGS84.

Informação e relatório disponível em:

www.gama.mm.gov.pt

Correio eletrónico:

iam@gama.mm.gov.pt

Report by the Maritime Accident Investigation and Aeronautical Meteorology Authority Office (GAMA) service of the State Central Administration whose mission is to investigate marine casualties and incidents with the highest efficiency and possible speed, to identify their respective causes, contributing factors, prepare and issue the corresponding reports and make recommendations on maritime safety that reduce maritime accidents.

This report has been prepared in compliance with the standards of the International Maritime Organization (IMO) and following the common methodology established by the European Union.

As provisions of Law No. 18/2012 of 07 May, which transposed Directive 2009/18 / EC of the European Parliament and of the Council, the GAMA investigations are independent of regulatory bodies, operators or others.

It is not the purpose of an investigation to determine guilt or liability.

This report should not be used for legal proceedings and not be used in court as evidence.

The safety recommendations resulting from this report may in no case create a presumption of liability or guilt. All times are local (UTC-3) and all positions have the geodetic datum WGS84 reference.

Information and available report:

www.gama.mm.gov.pt

E-mail:

iam@gama.mm.gov.pt

CONTENT

1. SUMMARY	page 4
2. NARRATIVE	page 4
2.1 Background	page 4
2.2 The accident – course of events	page 5
3. INVESTIGATION	page 11
3.1 The Zodiacs on board WE's	page 11
3.2 The Zodiac crew and the charter	page 11
3.3 Zodiac stability	page 11
4. ANALYSIS AND CONCLUSION	page 13
4.1 Autopsy reports	page 13
4.2 Understanding the accident	page 13
4.3 Accident causation	page 14
5. SAFETY RECOMMENDATIONS	page 15
6. APPENDIX	page 16

1. SUMMARY

On the 15th of November 2022, at 18:35 hours (ship's time – UTC 21:35) hours whilst the Portuguese flagged passenger vessel WORLD EXPLORER (WE) was at anchor – starboard side anchor with six shackles on deck – a cruising excursion crewed by the charter with eight (8) zodiacs and six (6) kayaks was deployed. The Zodiacs were of Lookout Cape, Elephant Island, when a VHF call was received on WE's bridge. The call, made from the excursion staff alerting that one zodiac capsized and there were multiple persons overboard in the water close to the shoreline. As a result, from the capsizing some passengers went beneath the capsized zodiac. All passengers were recovered from the water and taken ashore where they received medical assistance. Two passengers passed away after being recovered from the water.

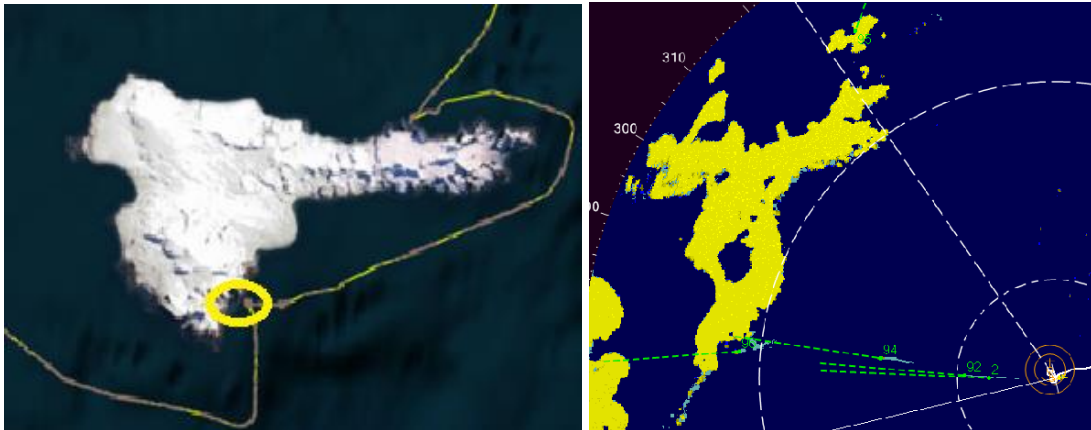

Figure 1 – Image of Elephant Island and location of the zodiac excursion.

2. NARRATIVE

The narrative of the course of events is based on the testimony of crew members from WE, staff from the charter company, Quark, and passengers from the capsized zodiac. The reconstruction of course of events covers the period from the deployment of the Zodiac excursion until the moment the crew and passengers were assisted on board WORLD EXPLORER (WE). Photo footages were obtained from the WE's Company. The narrative

2.1. Background

The passenger vessel WORLD EXPLORER was chartered by Quark Expeditions to the Antarctic season. The voyage where the accident occurred began and ended in the port of Ushuaia, Argentina on the 7th of November and 18th of November 2022, respectively. The vessel track is indicated in figure 2 below – Ushuaia port in the black circle and location of the capsizing in the red circle. The vessel was manned with 108 crew and 69 passengers (guests and Quark staff) on board. The capsizing occurred on the 9th day of the voyage. Before the capsizing there were four excursions conducted over three days in the South Georgia Islands. All persons on board Zodiac 04 on the day of the capsizing had been on previous excursions and had received a safety briefing from the Quark staff.

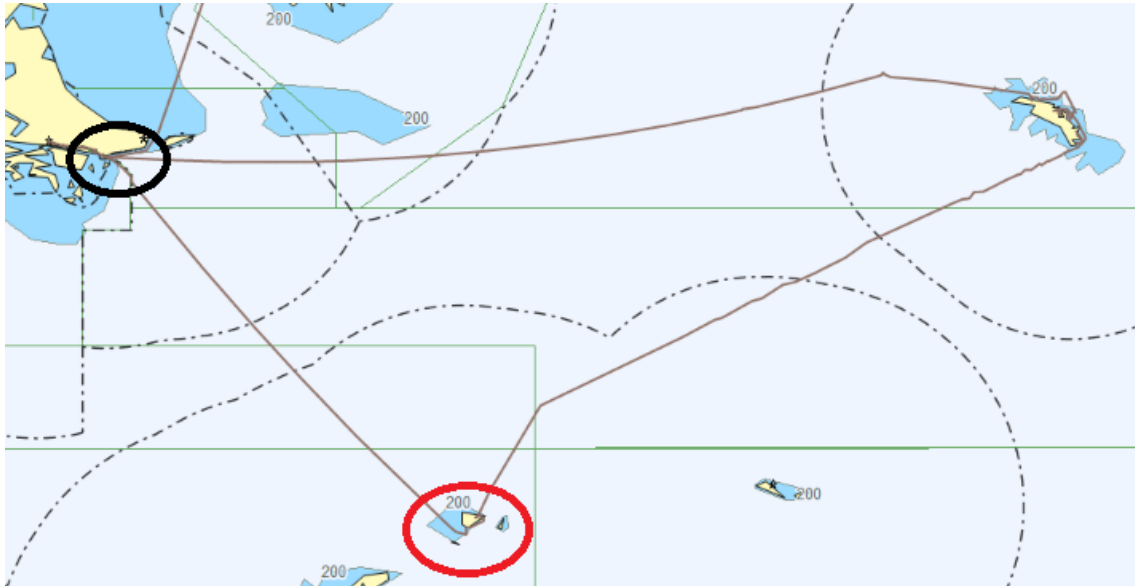

Figure 2

2.2. The accident – course of events

- 15/11/2022, around 18:00 hours

WORLD EXPLORER (WE) was at anchor, in the position indicated in figure 1, as part of a cruise chartered by Quark Expeditions. The planned activity for the day was an excursion to Lookout Cape, using inflatable boats (Zodiacs). Each Zodiac was crewed by staff of the charter's expedition team. The Zodiacs were prepared and lowered to the water by WE's crew and then delivered to the Quark staff. When the Zodiacs are crewed by the expedition staff, then the passengers embark the Zodiacs as indicated in figure 3 below;



Figure 3

- 15/11/2022, between 18:15 and 18:35 hours

Zodiac 04 was cruising westerly, in the direction of Lookout Cape, under way, using outboard engine, parallel to shoreline with a driver (Quark team lead), an ornithologist (Quark staff) and six guests (passengers) on board. The guests were seated three on each side of the Zodiac. The driver was standing on the stern

manning the Zodiac's tiller (engine) with his left hand. The guests and the Quark staff were all seated on the Zodiac's side pontoon sponsons (side inflatables boat tubes). The excursion was for wildlife sightseeing quite away off the shoreline, without landing. The driver stopped the Zodiac 04, about two hundred meters from the shore breaking waves (surf zone).

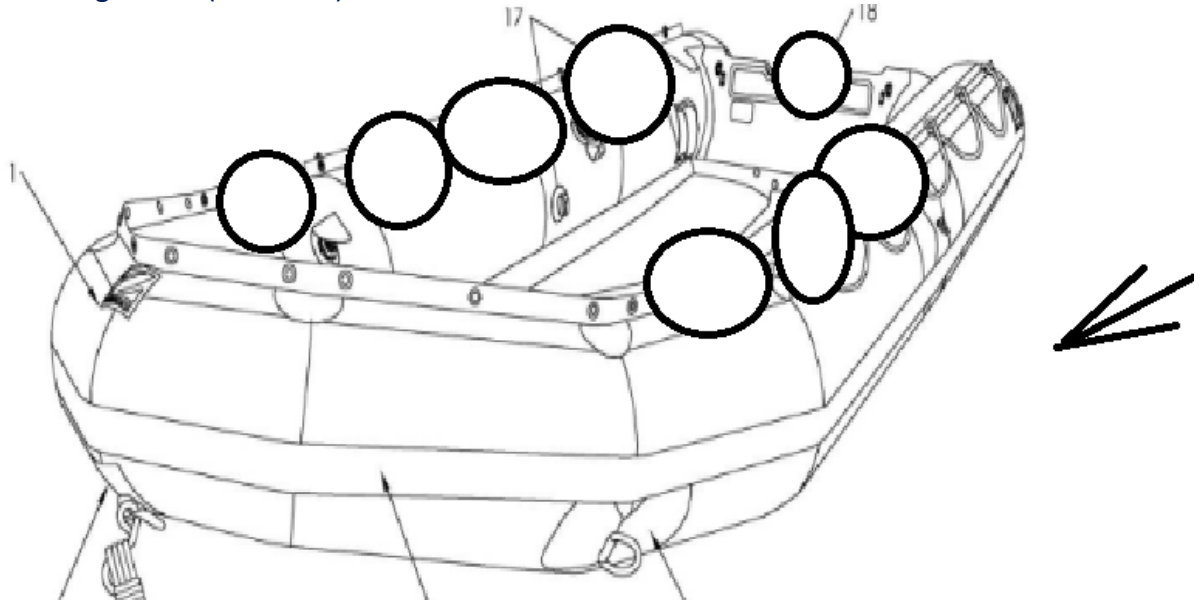

Figure 4 – Location of the driver, guests and Quark staff on starboard side and three guests on port side and direction of the wave that capsized Zodiac 04. The two guest that passed away were seated on port side.

The bow of Zodiac 04 was heading towards the surf zone while all persons onboard were looking at wildlife. One guest seated forward on starboard side saw a wave about to hit the Zodiac 04 on her port bow and alerted the driver. The driver then turned the bow of the Zodiac 04 to port, in the direction of the wave. When he made this manoeuvre, the driver saw a large wave, approximately two meters, already cresting to break. He stated that there was no time to make an evasive manoeuvre. The wave hit the port bow and flipped the Zodiac upside down with the port side rolling over the starboard side. In figure 5 below is the location of the capsizing.



Figure 5

All persons were overboard into the water.

The driver was underneath Zodiac 04 and manage to stay clear. When he was clear from the Zodiac 04, with his lifejacket inflated, he saw all guests floating with the lifejackets inflated, clear from Zodiac 04. The Zodiac 04 and persons in the water were hit by several breaking waves after the wave that capsized Zodiac 04. The Quark staff, guests and Zodiac 04 were pushed into shallow waters and the driver was able to stand up and get to shore approximately ten minutes after the capsized. The driver and the ornithologist helped moving the guests out of the water. The driver radioed a mayday call to his cruising partner (all Zodiacs travel in pairs);

- 15/11/2022, at 18:35 hours

A VHF call is received in the bridge of WE's. The call was made by the Quark's staff on board the partner Zodiac and reported one Zodiac capsized and a MOB (man overboard) situation, on the west side of Pinguin colony. Assistance was requested. The Zodiac was in the indicated position in figure 6 below;

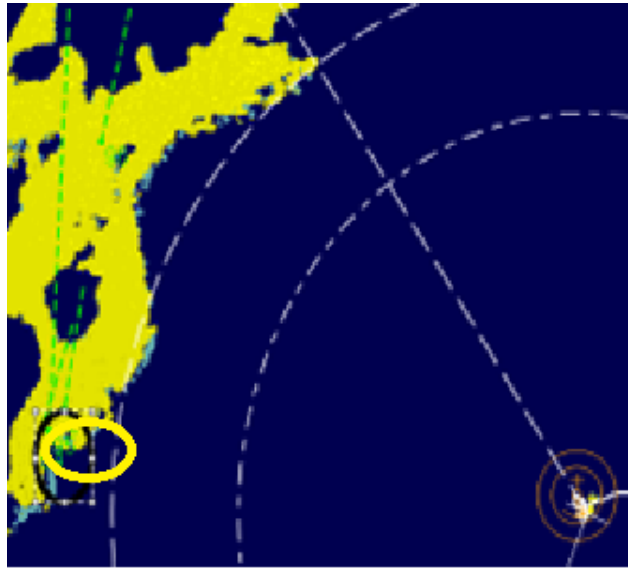

Figure 6

- 15/11/2022, at 18:36:17 hours
WE's bridge asks to the expedition leader if more Zodiacs are needed for assistance. The WE's Master, Staff Captain, Safety officer and doctor were informed;
- 15/11/2022, at 18:37:43
The expedition doctor on board of one Zodiac calls the WE's bridge and requests the bridge to inform the WE's doctor. A staff member from Expedition arrives at the bridge and asks, '*what is happening?*';
- 15/11/2022, at 18:39:12 hours
The bridge requests the WE's crew to lower other Zodiac and the expedition staff member on the bridge calls a staff member to crew the Zodiac. A communication from a Zodiac asking if it's possible to transfer the guests is heard;
- 15/11/2022, at 18:40:33 hours
A Zodiac informs, via VHF, it's returning to the ship.
- 15/11/2022, at 18:40:45 hours
Code Mike is broadcasted over WE's PA system
- 15/11/2022, at 18:42:12 hours
The WE's bridge team tries to identify the number of the capsized zodiac, mentioning that the number was not reported by the Expedition staff;
- 15/12/2022, at 18:44:24 hours
WE's bridge is informed that Zodiac 10 is lowered and on the water.
- 15/11/2022, at 18:47:57 hours
One Zodiac crew request, via VHF to the bridge, to move WE's closer to the MOB location. The distance from WE to Zodiac 04 is 2.51 nautical miles (nm) as indicated in figure 7 below.

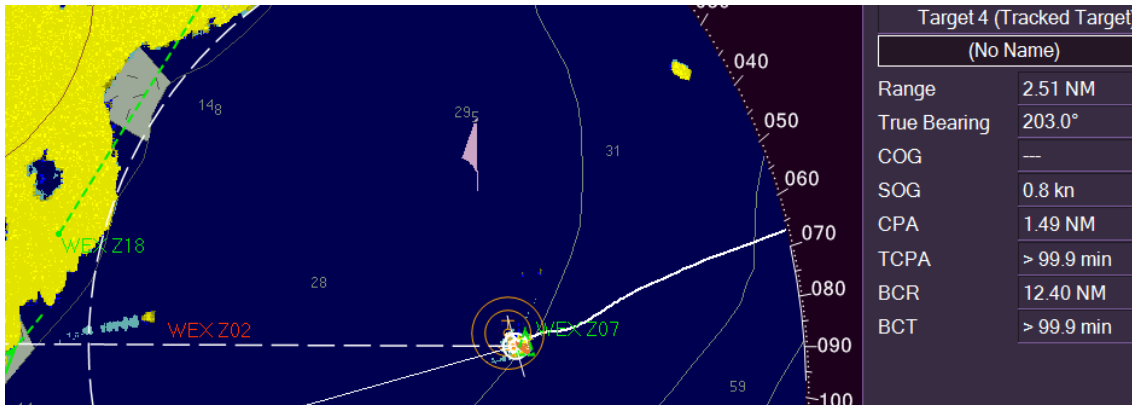

Figure 7

- 15/11/2022, at 18:49:40 hours
Bridge is informed that Zodiac 12 return to WE's with six guests on board and informed that the number of the capsized Zodiac is number 4.
- 15/11/2022, at 18:51:20 hours
Expedition doctor calls the bridge, via VHF, and informs there are two guest receiving CPR. Requests medical equipment to be deployed ashore and the WE's doctor to go ashore. The crew and guests from Zodiac 04 were taken ashore and are receiving medical assistance from another Zodiac crew that landed the beach with the expedition doctor. Zodiac 04 is capsized near the shoreline in an area with rocks. The Zodiac that landed was the one that earlier transfer it's guests.
- 15/11/2022, at 18:54 hours
WE's bridge calls the landed Zodiac and asks for a situation report. Bridge is informed that there were eight persons in Zodiac 04, six guests and two staff - the driver was the excursion team lead, the other staff was an expedition ornithologist. Bridge is informed that four of the guests are fine and two are receiving CPR. Zodiac 7 is proceeding to shore with WE's doctor. WE's start heaving up anchor to proceed closer to the accident location. WE's radar scale is altered to 1.5 nm;
- 15/11/2022, at 19:00 hours
Bridge is informed that two Zodiacs are returning to the vessel with guests.
- 15/11/2022, at 19:02 hours
The WE's doctor on board a Zodiac informs, via VHF, he cannot reach the coast.
- 15/11/2022, at 19:11 hours
The WE's doctor is ashore and asks the bridge to send more medical equipment to the accident location. WE's is under way using engine and proceeding closer to the accident location, as indicated in figure 8 below.



Figure 8

- 15/11/2022, at 19:19 hours
First information received from shore with total number of persons that went overboard from Zodiac 04 – six guests and two Quark staff.
- 15/11/2022, at 19:54 hours
First zodiac back to WE's with four injured persons, three guests (two able to walk and one needed to be lifted and taken by wheelchair to medical facility) and one Quark staff.
- 15/11/2022, at 20:05 hours
Zodiac 1 returns to WE's with ship's doctor and one injured (guest).
- 15/11/2022, at 20:21 hours
Bridge receives information that the two-guest receiving CPR ashore are deceased.
- 15/11/2022, at 21:06 hours
Zodiac with the two deceased guest arrives to WE's.
- 15/11/2022, at 21:55 hours
Capsized Zodiac 04 was towed and is on board WE's.

3. INVESTIGATION

Scope of the investigation

The course of events showed that the capsizing occurred as a surprise for the crew on board the Zodiac.

GAMA's maritime safety investigation focused on determining how the expedition staff was exposed to and managed an unrecognized hazard which arose in a planned excursion operation.

3.1. The Zodiac's on board WE's

The Zodiacs on board WE's belong to the vessel and were certificated by the Portuguese Maritime Administration.

The Zodiac's model is Mark Milpro International and Zodiac company states "This is a unique range of larger inflatables that is designed primarily to carry heavy loads at planning speeds due to its patented Futura hull shape. Figure 9 below shows the model and its characteristics".

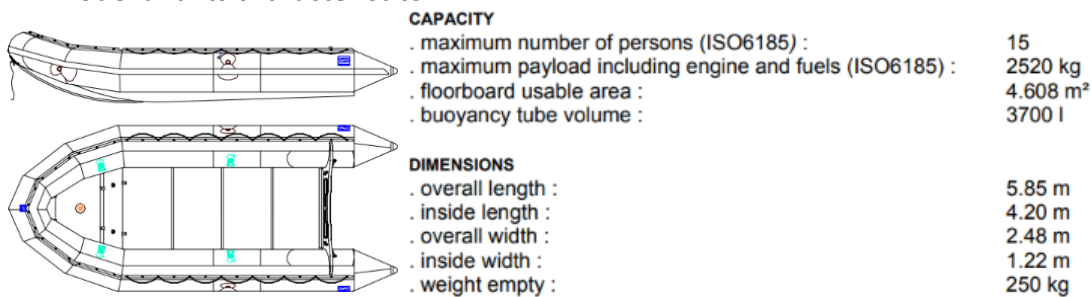

Figure 9

The twenty Zodiacs on board WE's are certified by Bureau Veritas and have a Station Licence certificate issued by the Portuguese Maritime Administration allowing the Zodiacs to use VHF and AIS frequencies 156-256 Mhz. Zodiac 04 international call sign is CQAJ7.

3.2. The Zodiac's crew and the charter

From the analysis of the Voyage Data Recorder (VDR) information the expedition staff is not comfortable in communicating an unexpected situation, such as MOB or a capsized vessel, on VHF. The initial call did not identify the Zodiac number. All the communication, except one, made from the expedition staff were not clear. The communications were understood by the officers on WE's bridge only because they are experts in understanding VHF communications. The Quark expedition staff crews the Zodiacs during excursions but onboard WE they are passengers, meaning they have no functions related to ship's safety on board. The excursions may occur daily or with long intervals between them due to sea and weather conditions.

On board WE's the officer of the watch (OOV) performs his/her watch on the bridge. OOV are certificated as such and even when performing his/hers tasks they are

assisted by a deck rating, an ordinary seaman (OS) or an able seaman (AB). The temporary skippers of the Zodiacs have other professional background and nevertheless when they are on board the Zodiacs, they are responsible for the vessel safe navigation, passengers' safety, and situation assessment. If occasionally the Zodiac is crewed with another expedition member, he or she does not have any function related to safety on board the Zodiac.

The training to drive a Zodiac is given by the charter.

3.3. Zodiac stability

- Stability can be defined as the ability that a vessel has to keep straight or the tendency to return to its upright position after being heeled over by any combination of wind, waves, or other forces.

A stable vessel has sufficient stability to counter the external forces generated by weather and other forces and keeps or returns to its upright position. An unstable vessel does not have sufficient stability to counter the external forces generated by weather and capsizes, as indicated in figure 10 below.

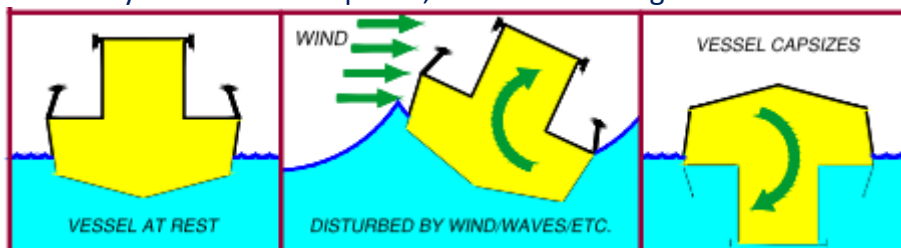

Figure 10

Whether a vessel is stable or unstable depends on two factors, the moments acting to right the vessel (vessel's hull shape and loading) and moments acting to capsize the vessel (weather, sea conditions and movement of weights on board). As long as the moments available to right the vessel are greater than the moment acting to capsize the vessel, it will remain upright and is considered stable.

- The forces that create a vessel's stability are gravity and buoyancy. Gravity is the force acting to pull the vessel down in the water, making it sink and buoyancy is the force acting to push the vessel up in the water making it float.
- Positive stability is when the combination of the center of gravity pulling down coupled with the center of buoyancy pushing up creates a righting action that forces the vessel back to its upright position. Negative stability is when the combination of the center of gravity and the center of buoyancy creates a capsizing action that forces the vessel to continue to roll over. Figure 11 below from United States Coast Guard 'A best practices guide to vessel stability' indicates these two moments.

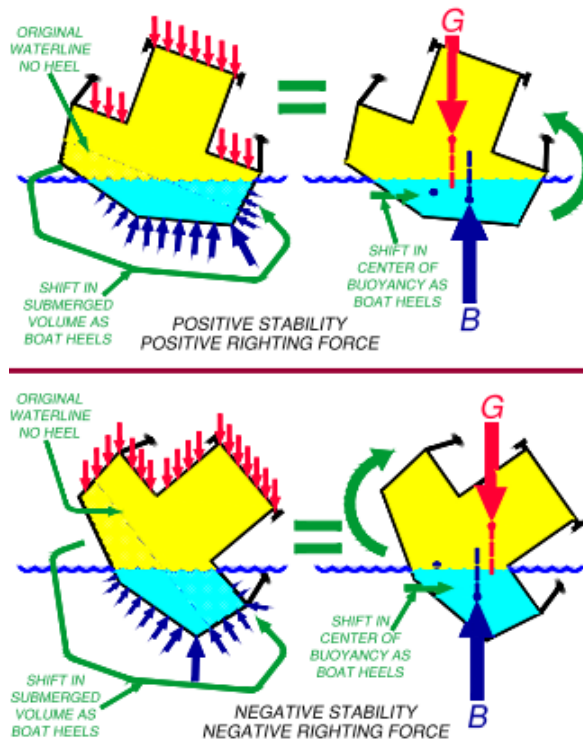

Figure 11

4. ANALYSIS AND CONCLUSIONS

4.1. Autopsy's report conclusions

The drowning produced by the immersion was the event that caused the death of both passengers (guests) on board Zodiac 04. Asphyxiation by submersion is the cause of both deaths.

4.2. Understanding the accident

- Handling surprises

From the information collected the driver was surprised by a breaking wave when the Zodiac was under way very slow ahead (one or two knots) or practically drifting. The Zodiac was operated by the driver who was responsible for all operational roles on board.

There was a rapid change in the context, detected by a guest seated forward on starboard side – a breaking wave approaching the Zodiac – causing a mismatch between what was expected to happen in the excursion and the reality.

It was not considered relevant for the present safety investigation the specific area where the capsizing occurred, because a Zodiac crewed by one person with passengers on board could be surprised at any location.

WE's OOW (experts in navigation and safety) always have an OS or an AB as a look out because it's necessary to i) be prepared to be surprised and ii) assess and react, if necessary, to overcome and achieve an acceptable outcome.

- Surprise and startle

Surprise is the unexpected and startle is a delay in physiological response to a sudden/dramatic shift. Startle delays the response and can disrupt initial processes to monitor, recognize, understand or even what it means for response.

The Zodiac driver was assessing the conditions, in following seas or beam seas with rocks ahead and a swell breaking in the vicinity. The driver was surprised with the unexpected conditions. Concluding that a crew of two on board the Zodiac is better than a crew of one.

- Following seas and beam seas

Operating or staying near drifting, in following seas (waves on the stern) or beam seas (waves on the vessel side) increases the danger of capsizing.

- Experience matters

The Quark staff on board the Zodiacs were organized in teams of two Zodiacs, this is a result of experience and contributed directly to the success of the rescue operation, considering that WE's was at anchor. The decision to transfer all guests from one Zodiac to another, to have a free Zodiac to proceed to the beach and assist in recovering the guests from the water was based on training and experience and contributed to the safety of the guest. Concluding that expertise and teamwork were crucial to minimize the possible more severe consequences of the man overboard situation.

4.3. Accident causation

The capsizing was a surprise to the only person on board who was responsible for:

- i) The Zodiac's safety,
- ii) the safety of the guests,
- iii) assessing the context to achieve an acceptable outcome,
- iv) VHF communications,
- v) communicating with the guests,
- vi) assessing weather and sea conditions.

Assessing the weather and sea conditions on board WE's to determine if a Zodiac excursion with Quark staff will be deployed, means predicting what might happen. It will never be possible to fully predict and anticipate all scenarios, therefore it's better to have well prepared and highly qualified crews when operating in real conditions with guests on board. This will enable operators to respond and overcome many situations including surprises.

GAMA's maritime safety investigations assume that though human error is attributed as a cause of maritime accidents, in fact human error is a symptom of underlying problems relating to interaction between humans, technology and organisations.

5. Safety recommendations and actions taken

Based on the analysis of the collected information related to the normal Zodiac operation and considering the scope of the safety investigation, the following safety recommendation is issued to WORLD EXPLORER Company:

- SR 01/2022-492

To assess the advantages of prioritizing the operational safety of the Zodiacs with guests onboard by having two crew members on board with specific functions – one skipper and one look-out.

The proposed safety recommendation was accepted by recipient.

After this occurrence the WE's management company and the charter, Quark Expeditions, initiated an investigation and decided to take the following actions:

- to have a Zodiac close to the gangway, ready to be displayed, together with specialized medical equipment, to minimize the reaction time to similar accidents.
- to have one of the WE's tenders ready at the embarkation deck station, on the opposite side of the gangway, to be lowered to assist if require, considering the capacity of the Zodiacs to provide adequate shelter.
- in future similar situations the message to all affected is passed in a more effective way, even sending a boat to reach of the locations as soon as possible, considering that heaving up the anchor to move closer to the accident location, caused some disturbance among the kayak users and some of the other passengers, not knowing why the vessel was heading up the anchor.

Circulation of the Safety investigation draft report

In accordance with the Portuguese Law, Act n. º 18/2012, of 7th May, a draft version of the present safety investigation report was circulated among the interested parties providing an opportunity for the report's scope, factual accuracy, and analytical logic to be checked and for comments to be provided.

The correction of factual errors and additions in detail (where relevant) have been included in this final safety investigation report, where deemed necessary. These reactions are not listed separately.

6. APPENDIX

Ship's particulars

Name	WORLD EXPLORER	ZODIAC 4
IMO number	9835719	
Flag	Portugal	Portuguese
Port of register	Funchal	
Call sign	CQAL5	CQAJ7
MMSI	255806193	
Length overall	126 meters	
Max. Breadth	19 meters	
Max. Draft	4,75 meters	
Gross tonnage	9923	
Classification society	Bureau Veritas	
ISM Company	Mystic Cruises SA	
Year of build	2019	
Hull material	Steel	
Type of vessel	Passenger Ship	
Total Crew (voyage)	108	
Total number passengers	69	
Engine manufacturer	Rolls Royce hybrid Propulsion Systems	
Type of engine	2 Diesel Engines – Bergen C25:33L8P	
Propelling power	5330 Kw	
ISM Company	Mystic Cruises	

Marine Casualty information and conditions at the time of the accident

Date and time	15/11/2022, at 18:25 hours
Position Latitude / Longitude	61° 15.55' S / 055° 11.34' W
Location	Antarctica, Elephant Island, Cape Lookout
Classification / severity	Very serious marine casualty
Consequences	Two fatal victims (passengers of Mv WORLD EXPLORER)
Nationality and age of the deceased	United States of America

Voyage data

Port of departure	Ushuaia
-------------------	---------

Port of destination	Ushuaia
---------------------	---------

Weather conditions on 15/11/2022 at 18:00 hours

Wind (Beaufort scale) North-westerly 8 knots
Swell South-westerly 0.5 meters
Natural light Daylight
Visibility Very good
Weather conditions Clear

Shore authority involvement and emergency response

World explorer doctor and crew
Quark Expeditions staff



República Argentina - Poder Ejecutivo Nacional
AÑO DE LA DEFENSA DE LA VIDA, LA LIBERTAD Y LA PROPIEDAD

Hoja Adicional de Firmas
Informe gráfico

Número:

Referencia: ISO World Explorer GAMA

El documento fue importado por el sistema GEDO con un total de 17 pagina/s.